

10/15/20/25/30/40 AC Output Solid State Relay W/ Integrated Heatsink

PCS45



FEATURES

- 4-32 VDC or 90-250 VAC Control
- 24-440 VAC Load Voltage
- Zero Cross or Random Switching
- Built In RC Snubber Output
- Triac Output Design
- Built In Finger Guard Cover
- LED Indicator
- RoHS Compliant
- Integrated Heatsink
- 35mm Din Rail or Panel Mount

INPUT PARAMETERS (Ta = 25°C)

Control Voltage Range	DC Input Max 35 VDC	4 VDC - 32 VDC
	250 VAC Input	90 VAC - 250 VAC
Must Turn-On Voltage	DC Input	3.5 VDC
	250 VAC Input	90 VAC
Must Turn-Off Voltage	DC Input	2 VDC
	250 VAC Input	10 VAC
Input Current	<20 mA	

OUTPUT PARAMETERS (Ta = 25°C)

Rated Load Current	10 A	15 A	20 A	25 A	30 A	40 A
Load Voltage Range	380 A		24 VAC - 440 VAC			
Max. Transient Overvoltage	380 A		900 Vpk			
Rated Load Current	10 A	15 A	20 A	25 A	30 A	40 A
Max. Surge Current (10 ms)	120 A	160 A	240 A	300 A	380 A	450 A
Max I ² t for Fusing (10ms, A ² s)	72	128	288	450	660	880
Min. Load Current	100 mA					
Max. Off-state Leakage Current	10 mA					
Max. On-state Voltage Drop	1.6 Vrms					
Max. Turn-on Time	DC Input (Zero)	1/2 Cycle + 1 ms				
	DC Input (Random)	1 ms				
	250 VAC Input	12 ms				
Max. Turn-off Time	DC Input	1/2 Cycle + 1 ms				
	250 VAC Input	40 ms				
Frequency Range	47 H - 63 Hz					
Min. Power Factor	0.5					
Min. Off-state dv/dt	500 V/μs					

CHARACTERISTICS

Dielectric Strength	2,500 VAC, 1 minute, Input/Output
Insulation Resistance	500 MΩ at 500 VDC, 50% RH
Operating Temperature	-30°C to 80°C
Storage Temperature	-30°C to 100°C
Relative Humidity	45 - 85% RH
Weight	228g (10/15A), 440g (20/25/30A), 940g (40A)

ORDERING INFORMATION

Example:	PCS45	-250A	-380A	-20	Z	L
Model:	PCS45 (SSR with Built In Heat Sink)					
Control Voltage:	D: 4 - 32 VDC; 250A: 90 - 250 VAC					
Load Voltage:	380A: 24 - 440 VAC					
Load Current:	10: 10 Amp 24 mm Width; 15: 15 Amp 24 mm; 20: 20 Amp 48mm; 25: 25 Amp 48mm; 30: 30 Amp 48mm; 40: 40 Amp 80mm;					
Switching Type:	Z: Zero Crossing, R: Random Turn-On					
Status LED:	L: LED Indicator					
Terminal Type:	Nil: Screw Terminal					

Box Quantity: XXX; Inner Box YYY

Dimensions

1 - 10-15 A

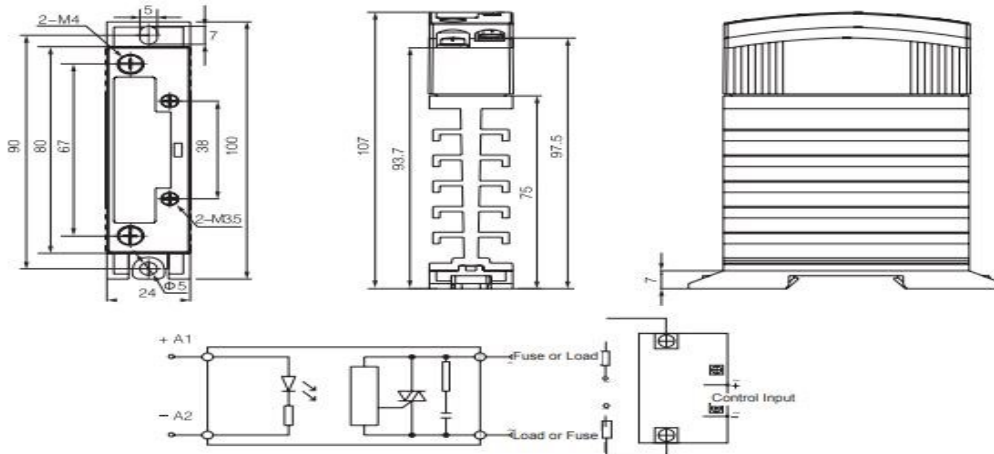

Dimensions in mm

2 - 20-30 A

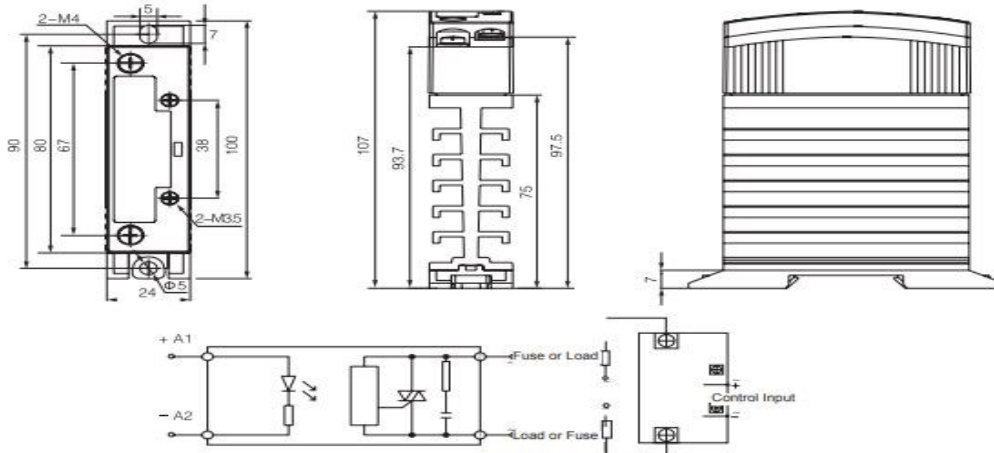

Dimensions in mm

3 - 40 A

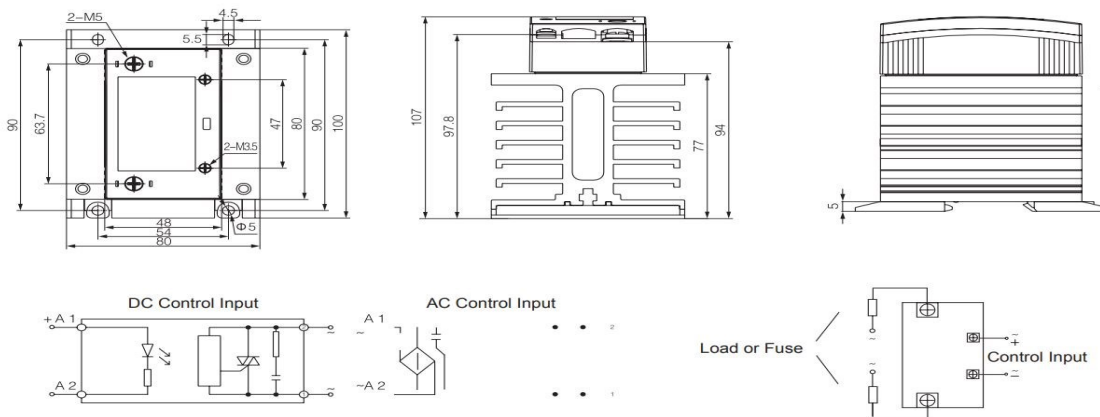

Dimensions in mm

Derating Curves

1 - 10-15 A

Input Current v. Control Voltage: 4 ~ 32VDC

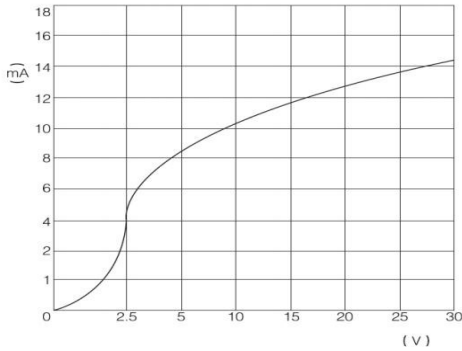

Load Current Derating v. Ambient Temperature

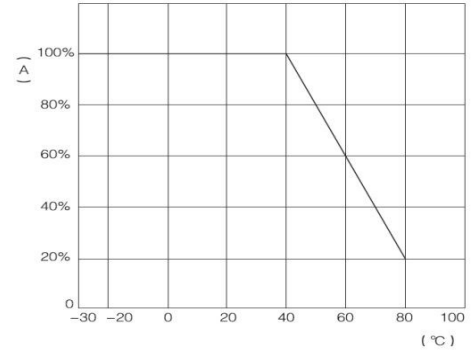

2 - 20-30 A

Input Current v. Control Voltage: 4 ~ 32VDC

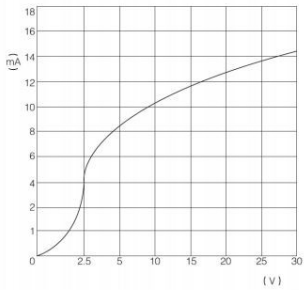

Input Current v. Control Voltage: 90 ~ 250VAC

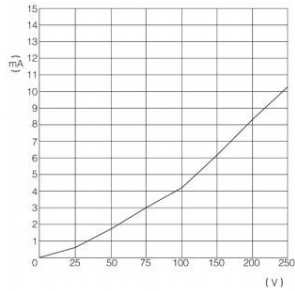

Load Current Derating v. Ambient Temperature

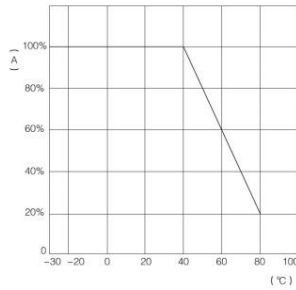

Load Output v. Input Control Action (Zero X-over)

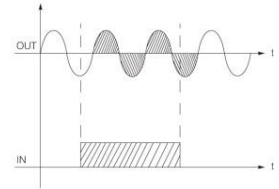

3 - 40 A

Input Current v. Control Voltage: 4 ~ 32VDC

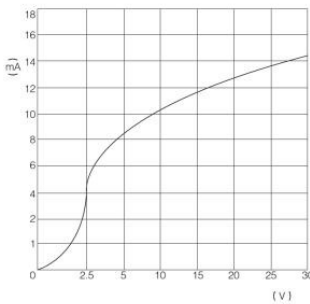

Input Current v. Control Voltage: 90 ~ 250VAC

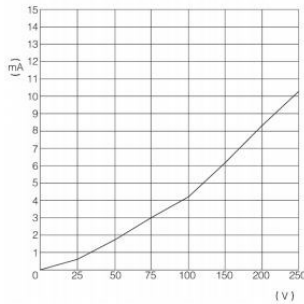

Load Current Derating v. Ambient Temperature

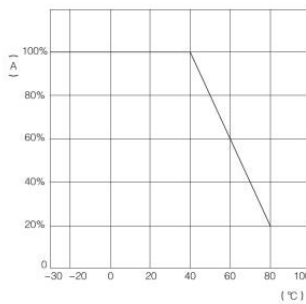

Load Output v. Input Control Action (Zero X-over)

