

Miniature 12 & 20 Amp General Purpose Relay

PC128



FEATURES

- 1 Pole: 12 Amp 250VAC/30VDC UL Rating
- 2 Pole: 8 Amp 250VAC/30VDC UL Rating
- Slim and Compact Size - 12.8mm Wide
- AC or DC Coils
- Test Button is Colored Coded AC=Red, DC=Blue
- Optional Lockable Test Button
- Optional Bi-Directional LED
- RoHS Compliant
- Several Variations of DIN Rail and PCB Sockets Available
- Socket Modules, ID Tags and Slip also Available

CA US Pending

Load Type	Voltage	1 Form C (SPDT)	2 Form C (DPDT)
General Purpose	250 VAC	12 A	8 A
	30 VDC	12 A	8 A
Motor	240 VAC	1/3 HP	1/6 HP
Max. Switching Power		3,000 VA 360 W	2,000 VA 240 W

CONTACT DATA

Material		AgCdO (Silver Cadmium Oxide)
Initial Contact Resistance		50 milliohms max
Service Life	Mechanical	1 X 10 ⁷ Operations
	Electrical	1 X 10 ⁵ Operations

CHARACTERISTICS

Operate Time	20 ms Max
Release Time	10 ms Max
Insulation Resistance	1,000 MΩ min (at 500 VDC)
Dielectric Strength	5,000 Vrms, 1 min. Between Coil and Contacts
	1,000 Vrms, 1 min. Between Open Contacts
	3,000 Vrms, 1 min. Between Contacts Poles
Shock Resistance	10 G

CHARACTERISTICS CONTINUED

Power Consumption	1 & 2 Pole DC 0.53 W, AC 1.0 VA
Vibration Resistance	10 Hz - 55 Hz DA 1.0 mm
Terminal Strength	8N; 4N PC Type
Solderability	260°C for 5 seconds
Operating Temperature	-40 to 55 °C
Relative Humidity	85% (at 30°C)
Weight	20 grams

ORDERING INFORMATION

Example	PC128	-2C	-24A	-LT	-X
Model:	PC128				
Contact Form:	1C: 1C SPDT, 2C: 2C DPDT				
Case Type:	Nil: Standard, C3: Top Flange				
Coil:	XXXA: AC Coils 6, 12, 24, 36, 48, 115, 220, 230, 240, 380 VAC (50/60 Hz) XXXD: DC Coils 6, 9, 12, 24, 36, 48, 110 VDC				
Contacts:	Nil: Silver Alloy G: Gold Clad Silver Alloy				
Options:	Without Test Button: L: LED, D: Diode, LD: LED + Diode (1-, 5+, 1-, 8+), LD1: LED + Diode (1+, 5-, 1+, 8-)				
	With Test Button: LT: LED, LTD: LED + Diode (1-, 5+, 1-, 8+), LTD1: LED + Diode (1+, 5-, 1+, 8-)				
RoHS Compliant:	X: RoHS Compliant				

Voltage Type	Coil Voltage		Resistance Ohms ± 10%	Must Operate Voltage Max.	Must Release Voltage Min.
	Coil Power	Rated			
DC 0.53 W		6	68	4.5	0.6
		9	150	6.75	0.9
		12	270	9	1.2
		24	1,100	18	2.4
		36	2,440	27	3.6
		48	4,300	36	4.8
		110	22,800	82.5	11
AC 1.0 VA		6	16	4.8	1.8
		12	63	9.6	3.6
		24	240	19.2	7.2
		48	1,085	38.4	14.4
		115	6,300	92	34.5
		220	21,000	176	66
		230	23,000	184	69
		240	25,000	192	72

NOTES:

- The use of any coil voltage less than the rated voltage will compromise the operation of the relays.
- Must Operate Voltage is listed for test purposes only and is not to be used as design criteria.
- Pickup and release voltages are for test purposes only and are not to be used as design criteria.

DIMENSIONS (mm/inches)

1 Form C without Test Button

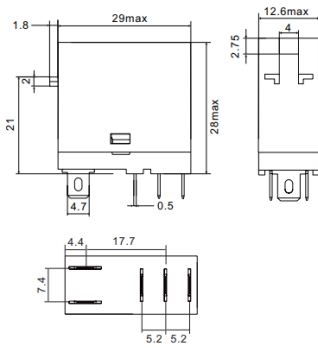

1 Form C with Test Button

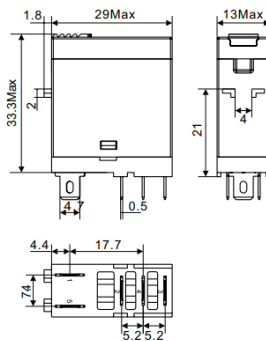

Top Flange Dimension

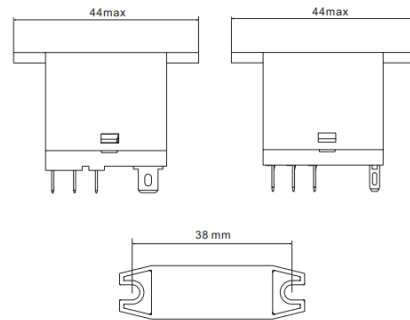

2 Form C without Test Button

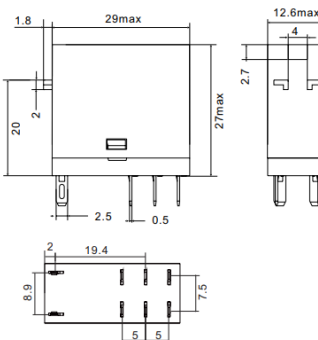

2 Form C with Test Button

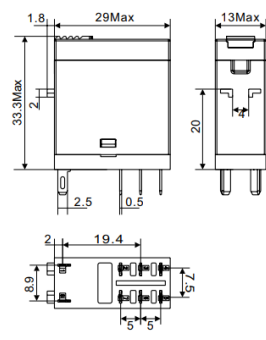

Wiring Diagrams

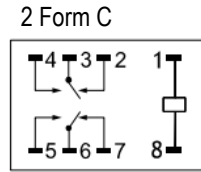
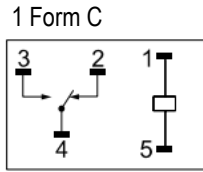

AC with LED

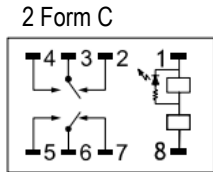
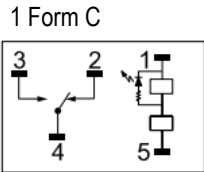

DC with LED and Diode

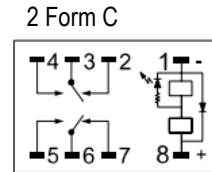
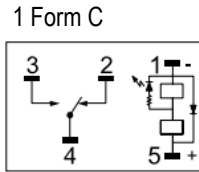

DC with LED

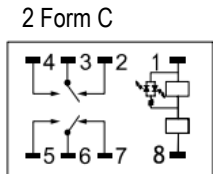
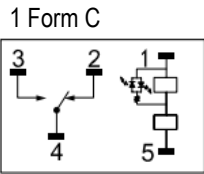

DC with LED and Diode, Reverse Orientation

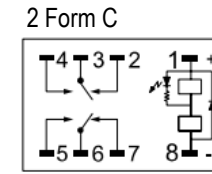
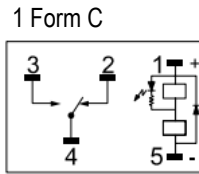

Reference Data

1 Form C

Electrical durability contacts (resistive load)

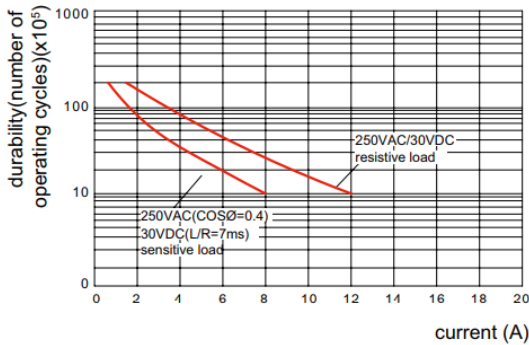

Maximum switching capacity on resistive load

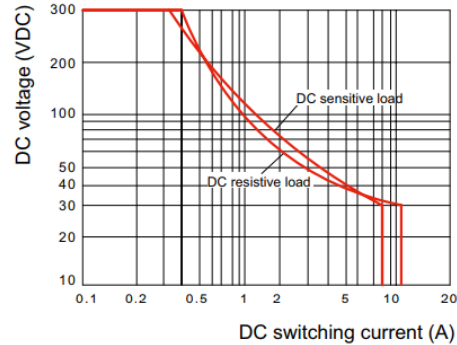

2 Form C

Electrical durability contacts (resistive load)

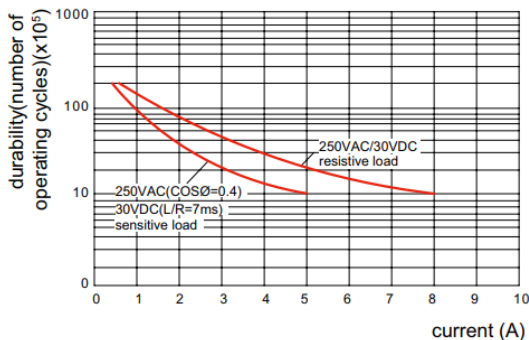

Maximum switching capacity on resistive load

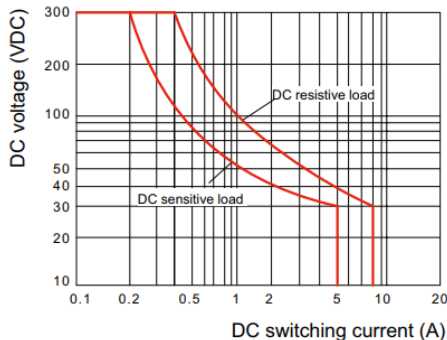

PC128 Sockets

SC128-05-SE / SC128-08-SE



10/16 AMPS 300 VOLTS



DIMENSIONS (mm/inches)

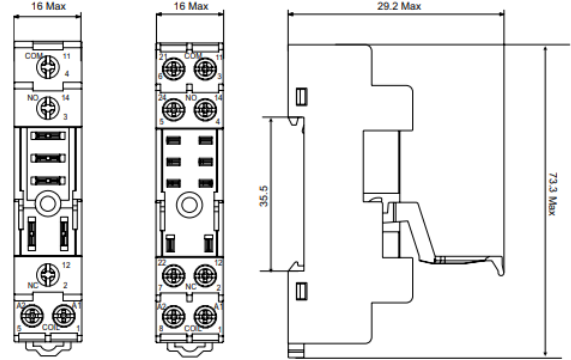

SC128-05-SE SC128-08-SE

Characteristics

Type		SC128-05-SE	SC128-08-SE
Nominal	Current	16 A	10 A
	Voltage	300 V	
Dielectric Strength	Between Coil and Contact	4,000 V/s	
	Between Contacts	2,500 V/s	
Max Tightening Torque		1.0 Nm	
Wire Size		20-14/0.5-2.5 AWG/mm ²	
Ambient Temperature		-45 to 85°C	
Unit Weight		22 g	27 g

Wiring Diagrams

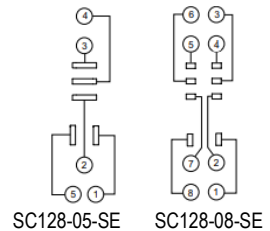

SC128-05-SE SC128-08-SE

Relay Accessories

Socket	Bus Jumper	Plastic Clip	DIN Rail
SC128-1C-SE	PR08C	PR20 (Included)	PFP
SC128-2C-SE			

SC128-05-SA / SC128-08-SA



10/16 AMPS 300 VOLTS



DIMENSIONS (mm/inches)

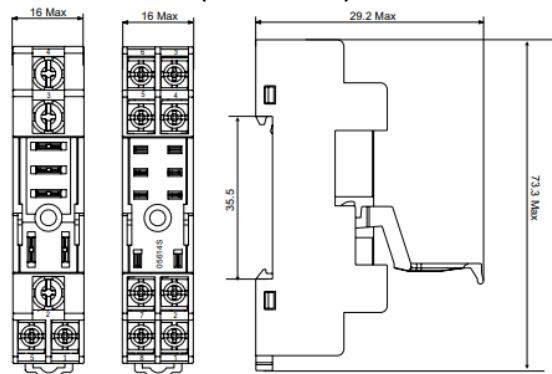

SC128-05-SA SC128-08-SA

Characteristics

Type		SC128-05-SA	SC128-08-SA
Nominal	Current	16 A	10 A
	Voltage	300 V	
Dielectric Strength	Between Coil and Contact	4,000 V/s	
	Between Contacts	2,500 V/s	
Max Tightening Torque		1.0 Nm	
Wire Size		20-14/0.5-2.5 AWG/mm ²	
Ambient Temperature		-45 to 85°C	
Unit Weight		22 g	27 g

Wiring Diagrams

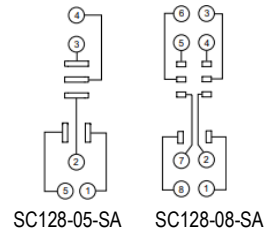

SC128-05-SA SC128-08-SA

Relay Accessories

Socket	Bus Jumper	Plastic Clip	DIN Rail
SC128-1C-SA	PR08C	PR20 (Included)	PFP
SC128-2C-SA			

SC128-05-SU / SC128-08-SU



10/16 AMPS 300 VOLTS



DIMENSIONS (mm/inches)

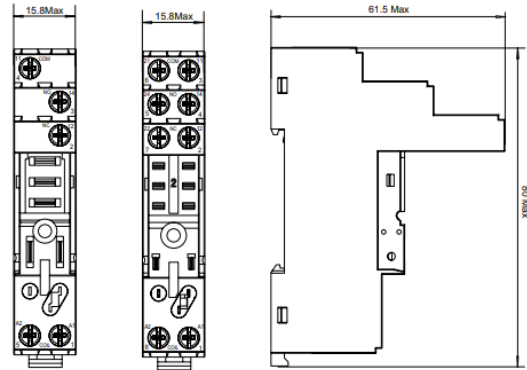

SC128-05-SU SC128-08-SU

Wiring Diagrams

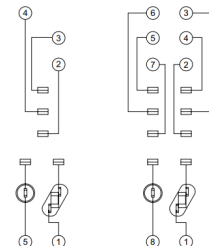

SC128-05-SU SC128-08-SU

Characteristics

Type		SC128-05-SU	SC128-08-SU
Nominal	Current	16 A	10 A
	Voltage	300 V	
Dielectric Strength	Between Coil and Contact	4,000 V/s	
	Between Contacts	2,500 V/s	
Max Tightening Torque		1.0 Nm	
Wire Size		20-14/0.5-2.5 AWG/mm ²	
Ambient Temperature		-45 to 85°C	
Unit Weight		35 g	43 g

Relay Accessories

Socket	Bus Jumper	Plastic Clip	DIN Rail	Module	ID Tag
SC128-1C-SE	PR08B	PR20T	PFP	PMA128	PR2P
SC128-2C-SE					

SC128-05-PCB / SC128-08-PCB



10/16 AMPS 300 VOLTS



DIMENSIONS (mm/inches)

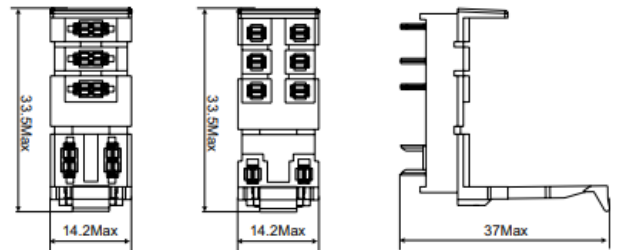

SC128-05-PCB SC128-08-PCB

Wiring Diagrams

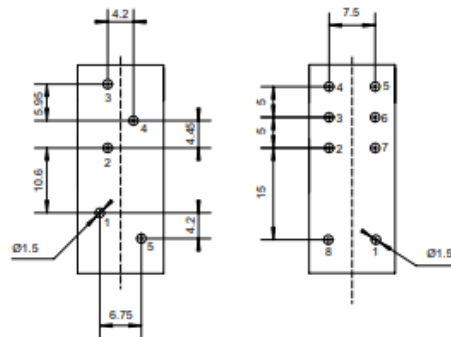

SC128-05-PCB SC128-08-PCB

Characteristics

Type		SC128-05-PCB	SC128-08-PCB
Nominal	Current	16 A	10 A
	Voltage	300 V	
Dielectric Strength	Between Coil and Contact	4,000 V/s	
	Between Contacts	2,500 V/s	
Ambient Temperature		-45 to 85°C	
Unit Weight		4 g	

PC128 Modules

PMA128

DIMENSIONS

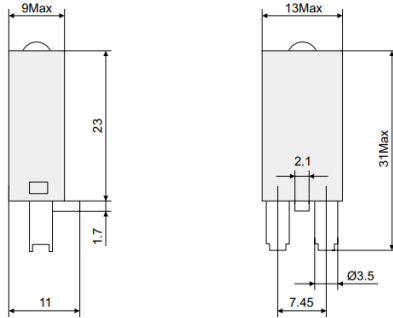

FEATURES

- Various Surge Suppressor Techniques
 - ◊ Single Diode
 - ◊ Resistor and Capacitor in Series
 - ◊ Varistor
- Optional LED
- For Use With SC128-xx-SU Socket

ORDERING INFORMATION

Example:	PMA	-L	1	6-24VACDC
Model:	PMA			
Description:	L: LED, LD: LED + Diode, D: Diode, ML: Varistor + LED, M: Varistor, RC: RC Circuit			
Polarity:	Nil: A1 = - A2 = +, 1: A1 = + = -A2			
Voltage:	Voltage options shown below in ordering options and schematics			

EXAMPLES

PMA-L-6-24VACDC
PMA-LD-110V240VDC
PMA-D1-6-250VDC

ORDERING OPTIONS AND SCHEMATICS

PMA-L 6-24VAC/DC	PMA-L1 6-24VAC/DC	PMA-L 110-240VAC/DC	PMA-L1 110-240VAC/DC	PMA-LD 6-24VDC				
AC/DC circuit + LED	AC/DC circuit + LED	AC/DC circuit + LED	AC/DC circuit + LED	DC circuit + LED + Diode				
PMA-LD1 6-24VDC	PMA-LD 110V/240VDC	PMA-LD1 110V/240VDC	PMA-D 6-250VDC	PMA-D1 6-250VDC	PMA-ML 24VAC/DC	PMA-ML1 24VAC/DC	PMA-ML 120VAC/DC	
DC circuit + LED + Diode	DC circuit + LED + Diode	DC circuit + LED + Diode	DC circuit + Diode	DC circuit + Diode	AC/DC circuit + LED + Varistor	AC/DC circuit + LED + Varistor	AC/DC circuit + LED + Varistor	
PMA-ML1 120VAC/DC	PMA-ML 240VAC/DC	PMA-ML1 240VAC/DC	PMA-RC 6-24VAC	PMA-RC 110V/240VAC	PMA-M 24VAC/DC	PMA-M 120VAC/DC	PMA-M 240VAC/DC	
AC/DC circuit + LED + Varistor	AC/DC circuit + LED + Varistor	AC/DC circuit + LED + Varistor	AC circuit + RC	AC circuit + RC	AC/DC circuit + Varistor	AC/DC circuit + Varistor	AC/DC circuit + Varistor	